

Composite dry sliding bushings, metric dimensions

Principal dimensions			Basic load ratings		Mass	Designation
d	D	B	dynamic C	static C0		
mm			kN		kg	-
14	16	15	16,6	52	0,0052	PCM 141615 E

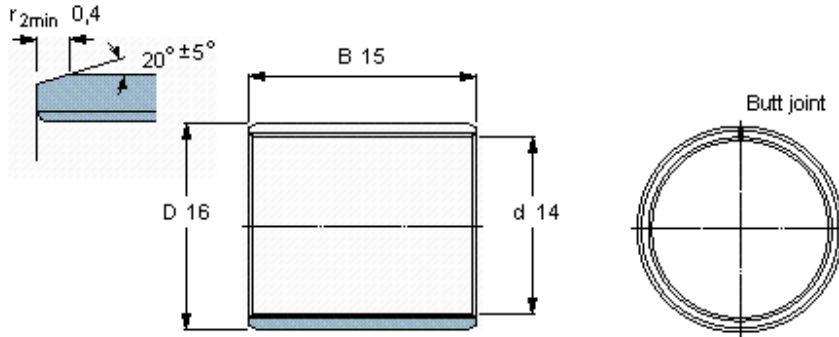

Specific load factor
Material constant

K 80
K_M 480